

Dehumidifier

Operating Instructions



Operating Instructions

1 Features

Powerful Dehumidifying Capability

Taking advantage of refrigeration technology, the dehumidifier powerfully removes moisture from the air to decrease the humidity level of the room and keep the indoor air dry and comfortable.

Lightweight Portable Design

The dehumidifier is built to be compact and lightweight. The casters on the bottom of the unit make it easy to move from room to room.

Low Temperature Operation with Automatic Defrost

When the unit is running in a room temperature between 5 C° and 12 C°, it will stop to defrost every 30 minutes. When the unit is running in a room temperature between 12 C° and 20 C°, it will stop to defrost every 45 minutes.

Adjustable Humidity

Set the desired humidity level with the humidistat.

Timer On / Off

Program the unit to turn on and off automatically.

Quiet Operation

The dehumidifier operates with a low noise level.

Energy Efficient

The power consumption of the unit is low.

2 Safety Warnings

When using the unit, please observe the following safety precautions:

1. Unplug the power supply cord before cleaning or storage.
2. The appliances can be used indoor but not in laundry rooms.
3. Do not set the unit close to heat-generating devices or near flammable and dangerous materials.
4. Never put your fingers or objects into the intake or discharge ducts.
5. Do not sit or stand on the unit.
6. Discard water that has collected in the tank as required.
7. Do not operate the dehumidifier in a closed area such as inside a closet, as it may cause a fire.
8. Do not use the unit near edible items, art objects, medical equipment, or scientific apparatus.
9. Install drain piping at a downhill grade to make sure that condensed water can be drained continuously.
10. If the power supply cord is damaged it must be replaced by the manufacture or a similarly qualified person in order to avoid a hazard.
11. The appliance must be positioned so that the plug is accessible.
12. Please keep a distance 20 cm around the unit and the wall or other objects to ensure air circulation.
13. The appliance shall be installed in accordance with local national regulations.
14. The appliance can not be used in public transportation.
15. This appliance can be used by children aged from 8 years and above and persons with reduced physical, sensory or mental capabilities or lack of experience and knowledge, if they have been given supervision or instruction concerning the use of the appliance in a safe way and understand the hazards involved. Children should not play with the appliance. Cleaning and maintenance should not be done by children without supervision.
16. Appliances that are obviously damaged must not be operated.

GENERAL WARNINGS

1. Do not use any means to accelerate the defrosting process or to clean, other than those recommended by the manufacturer.
2. The appliance should be stored in a room without any ignition sources (for example: open flames, an operating gas appliance or an operating electric heater).
3. Appliance should be installed, operated and stored in a room with a floor area larger than 4 m².
4. The appliance should be compliance with national gas regulations.
5. Any person who is maintaining or repairing the refrigerant circuit should hold a current valid certificate from an industry-accredited assessment authority, which authorises their competence to handle flammable refrigerants safely in accordance with an industry recognised assessment specification.
6. Servicing should only be performed as recommended by the manufacturer.
7. Appliance is filled with flammable gas R290.
8. If you need any repairs, contact the nearest authorized service centre.



DISPOSAL WARNINGS

1. Do not dispose of electrical appliances with other unsorted household waste - use separate collection facilities. Contact your local municipality for information regarding the collection systems available for electronic waste.
2. Disposal of this type of appliance in nature or other improper locations endangers your health and the environment and is prohibited.

The dehumidification capacity is rated at a room temperature of 30°C with a relative humidity of 80%. The operational temperature is in the range of 7° to 35°C and max relative humidity of 80%. If the room temperature is outside of this range, the unit will not operate normally. GWP value of R290 refrigerant is 3.

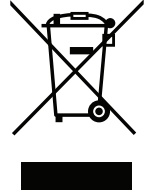

3 Product Information

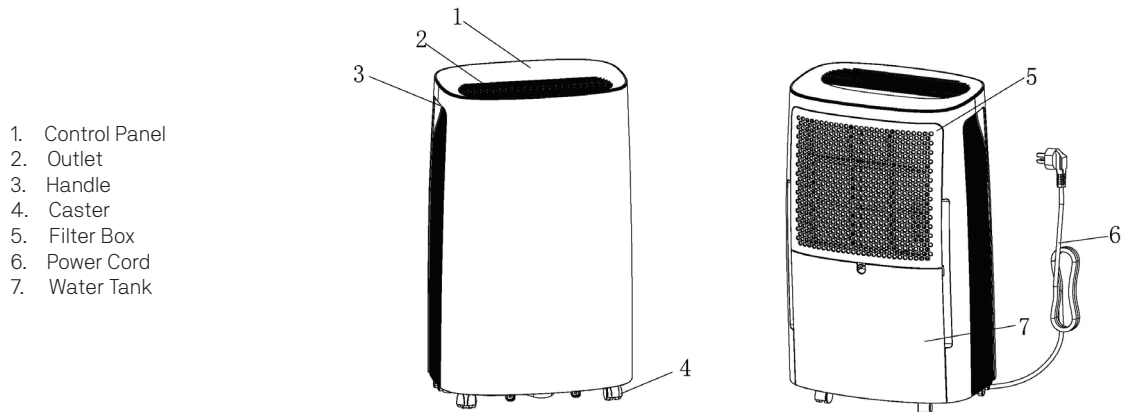

4 Humidity Level & Timer 2 Digit Display

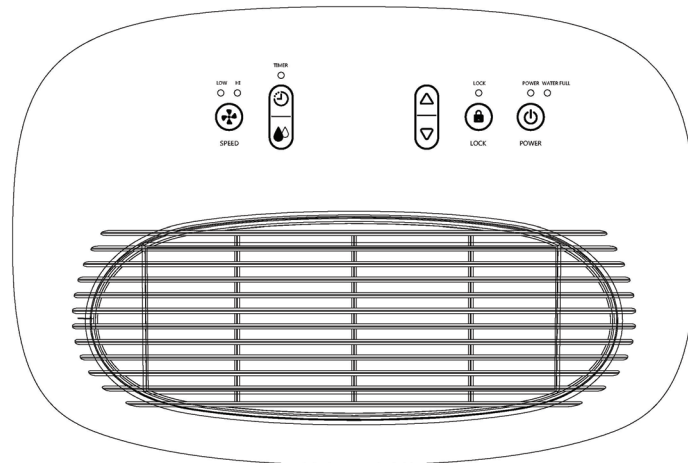



The indicator has 3 functions:

1. When the unit is plugged in, it will indicate the room humidity level.
2. When the humidity is set, it will indicate the humidity level selected.
3. When you program the time for the unit to turn on and off, it will show the set time.
4. When the environment humidity is lower than 35%, it will show "35".
5. When the environment humidity is higher than 95%, it will show "95".



5 Operation

The alarm will ring several times when the unit is turned on and the room humidity will be shown for 3 seconds.

1. Turn on/off

Press  to start the unit. Press  to turn it off.

2. Humidity setting

Press the  key to enter humidity-setting mode, then press  or  to adjust the humidity between 40% and 80%. You can set the humidity level in increments of 5%. When you stop pressing any key for 5 seconds, the display will return to normal. The default value of humidity is 55%.



3. Fan-speed setting

Press  to set the fan speed to high or low, and the corresponding fan speed light will turn on.

4. Lock setting

After the appliance has started, press the  key to lock in the settings. Press the  to unlock.

5. Time setting

Press  to enter shutdown-timer setting mode. Set when the unit should stop by looking at the time on the display. Press  or  button to adjust the time between 1 and 24 hours.

If the dehumidifier is turned off by the user or has the water tank full, it may cancel the shutdown-timer function.

6 Draining the Collected Water

When the water tank is full, the tank full indicator light will turn on. The operation will stop automatically and the alarm will ring 15 times to alert the user that the water needs to be emptied from the tank.

Emptying the Water Tank:

1. Lightly press on the sides of the tank with both hands and pull the tank out gently as shown below.

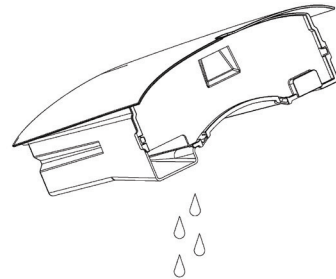
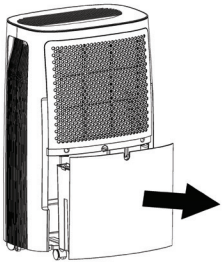

2. If the water tank is dirty, wash it with cold or lukewarm water. Do not use detergent, scouring pads, chemically treated dust cloths, gasoline, benzene, thinner, or other solvents, as these can damage the tank and cause water leakage.

3. When reinstalling the water tank, firmly press it into place with both hands. If the tank is not positioned properly, the 'TANK FULL' sensor will be activated, and the dehumidifier will not operate.

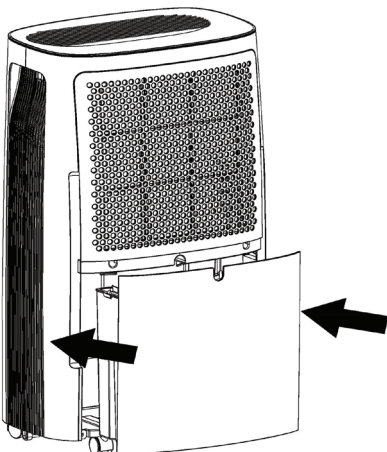

Continuous Water Drainage:

The unit features a continuous drainage port. Insert a plastic pipe (with an inner diameter of 10mm) into the drain hole (on intermediate plate). Extend the pipe from the side of the water tank, secure it in place, and arrange the drain pipe accordingly. This setup allows the water in the drainage tank to be continuously expelled through the unit's drainage port.

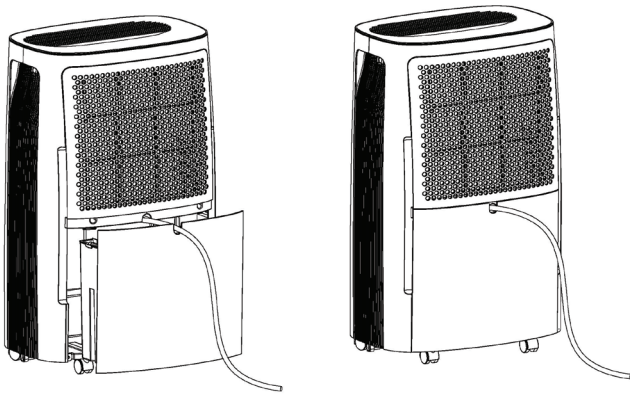

7 Maintenance

To clean the outside of the appliance, wipe it with a damp cloth.

Cleaning the Air Filter

1. Open the inlet grill and remove the air filter as shown below.

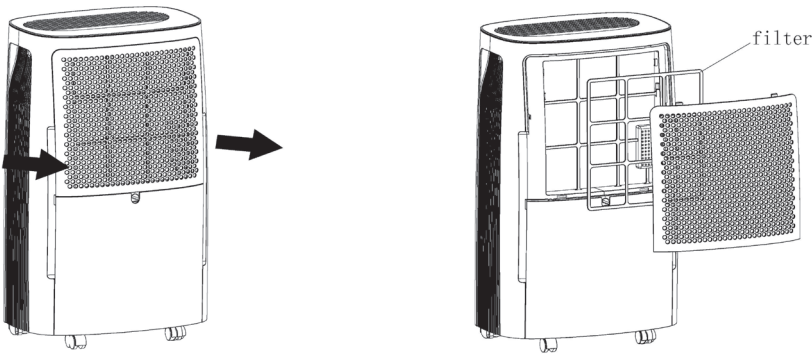

2. Run a vacuum cleaner lightly over the surface of the air filter to remove any dirt. If the air filter is exceptionally dirty, wash it with warm water and dry it thoroughly.

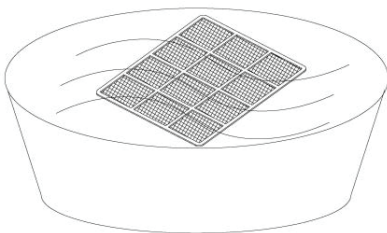

3. Insert the filter back into the dehumidifier, and push the inlet grill into place.

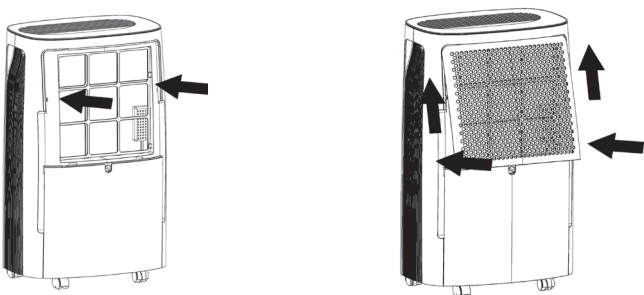

Storing the Dehumidifier

When the unit is not being used for a long period of time and you want to store it note the following steps:

1. Empty any water left in the water tank.
2. Fold up the power supply cord and put it in the dry water tank.
3. Clean the air filter.
4. Store the dehumidifier in a cool and dry place.

Maintain a minimum of 20 cm of empty space around the dehumidifier when the unit is in use.

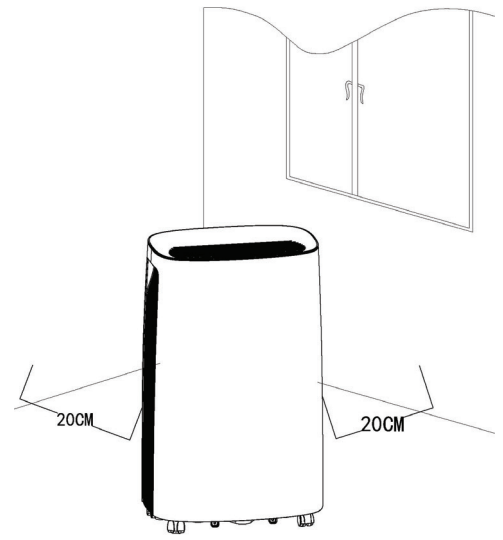

8 Troubleshooting

If a condition listed below occurs, please check the following possible solutions before calling customer service.

Problem	Possible Cause	Solution
The unit doesn't operate	Has the power cord been disconnected?	Plug the power cord into the outlet.
	Is the temperature of the room above 35°C or below 5°C?	The protection mode is activated and the unit cannot be started.
	Is the tank full indication light blinking? (The tank is full or in a wrong position.)	Empty the water in the tank and then reposition the tank.
The dehumidifying function doesn't work	Is the air filter clogged?	The protection mode is activated and the unit cannot be started.
	Is the intake duct or discharge duct obstructed?	Remove the obstruction from the discharge duct or intake duct.
No air is discharged	Is the air filter clogged?	Clean the air filter as instructed under "Maintenance".
Operation is noisy	Is the unit tilted?	Move the unit on a flat surface.
	Is the air filter clogged?	Clean the air filter as instructed under "Maintenance".